

Description

The DCSM24CH is a bi-directional TVS diode array, utilizing leading monolithic silicon technology to provide fast response time and low ESD clamping voltage, making this device an ideal solution for protecting sensitive semiconductor components from damage. The DCSM24CH complies with the IEC 61000-4-2 (ESD) standard with $\pm 30\text{kV}$ air and $\pm 30\text{kV}$ contact discharge. It is assembled into a lead-free SOT-23 package. It is designed to protect components which are connected to data and transmission lines from voltage surges.

Mechanical Characteristics

- ◆ Package: SOT-23
- ◆ Lead Finish: Matte Tin
- ◆ Case Material: "Green" Molding Compound.
- ◆ Moisture Sensitivity: Level 3 per J-STD-020
- ◆ Terminal Connections: See Diagram Below
- ◆ Marking Information: See Below

Dimensions and Pin Configuration

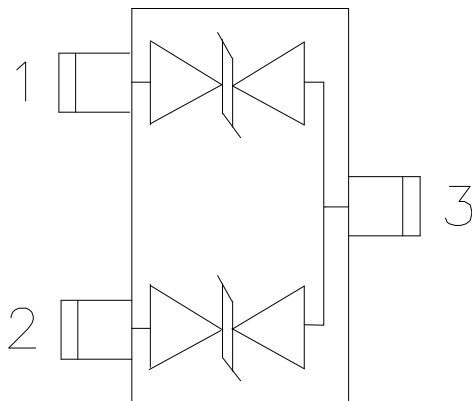

Circuit and Pin Schematic

Features

- ◆ Protects two uni-directional lines
- ◆ Ultra low leakage: nA level
- ◆ Operating voltage: 24V
- ◆ Low clamping voltage
- ◆ Complies with following standards:
 - IEC 61000-4-2 (ESD) immunity test
 - Air discharge: $\pm 30\text{kV}$
 - Contact discharge: $\pm 30\text{kV}$
 - IEC61000-4-5 (Lighting) 13A (8/20 μs)
- ◆ RoHS Compliant

Applications

- ◆ Cellular Handsets and Accessories
- ◆ Notebook and Handhelds
- ◆ Portable Instrumentation
- ◆ Set Top Box
- ◆ Industrial Controls
- ◆ Server and Desktop PC

Marking Information

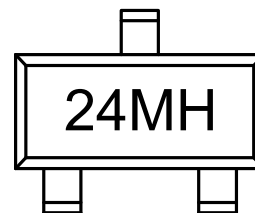

24MH= Device Marking Code

Ordering Information

| Part Number | Marking | Packaging | Reel Size |
|-------------|---------|------------------|-----------|
| DCSM24CH | 24MH | 3000/Tape & Reel | 7 inch |

Absolute Maximum Ratings ($T_A=25^{\circ}\text{C}$ unless otherwise specified)

| Parameter | Symbol | Value | Unit |
|--|------------------|----------------------|--------------------|
| Peak Pulse Power (8/20 μs) | Ppk | 450 | W |
| Peak Pulse Current (8/20 μs) | I _{PP} | 13 | A |
| ESD per IEC 61000-4-2 (Air) ESD per IEC 61000-4-2 (Contact) | V _{ESD} | ± 30 ± 30 | kV |
| Operating Temperature Range | T _J | -55 to +125 | $^{\circ}\text{C}$ |
| Storage Temperature Range | T _{stg} | -55 to +150 | $^{\circ}\text{C}$ |

Electrical Characteristics ($T_A=25^{\circ}\text{C}$ unless otherwise specified)

| DCSM24CH | | | | | | |
|-------------------------|------------------|-----|-----|------|---------------|--|
| Parameter | Symbol | Min | Typ | Max | Unit | Test Condition |
| Reverse Working Voltage | V _{RWM} | | | 24 | V | |
| Breakdown Voltage | V _{BR} | 25 | | | V | I _T = 1mA |
| Reverse Leakage Current | I _R | | | 0.2 | μA | V _{RWM} = 24V |
| Clamping Voltage | V _C | | | 32 | V | I _{PP} = 1A (8 x 20 μs pulse) |
| Clamping Voltage | V _C | | | 34.5 | V | I _{PP} = 13A (8 x 20 μs pulse) |
| Dynamic Resistance | R _{DNY} | | 0.1 | | Ω | I _{TLP} =8A to 16A |
| Junction Capacitance | C _J | | 15 | | pF | V _R = 0V, f = 1MHz, Pin 1 to Pin 3 or Pin 2 to Pin 3 |
| Junction Capacitance | C _J | | 7 | | pF | V _R = 0V, f = 1MHz, Pin 1 to Pin 2 |

Typical Performance Characteristics (TA=25°C unless otherwise Specified)

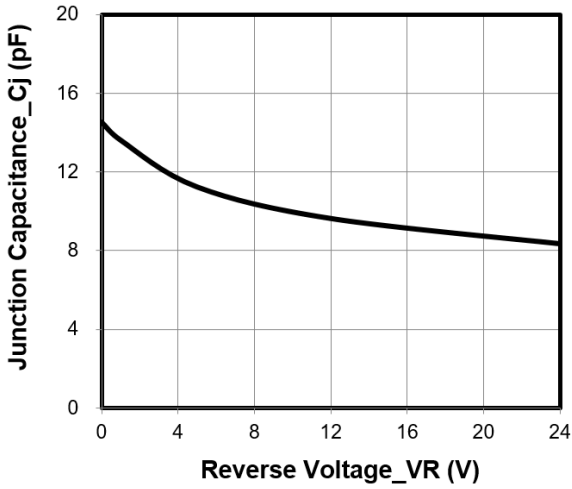

Junction Capacitance vs. Reverse Voltage

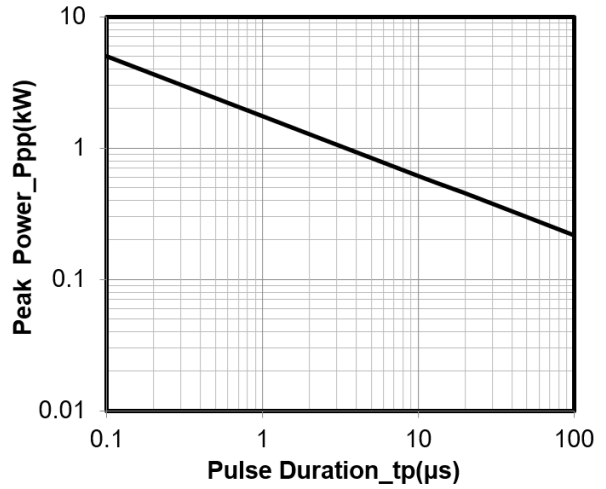

Peak Pulse Power vs. Pulse Time

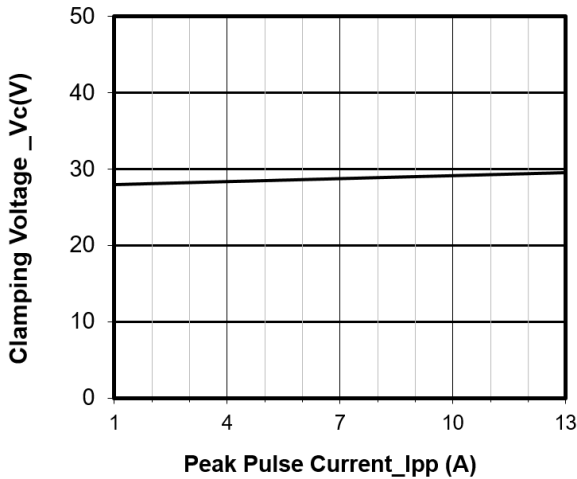

Clamping Voltage vs. Peak Pulse Current

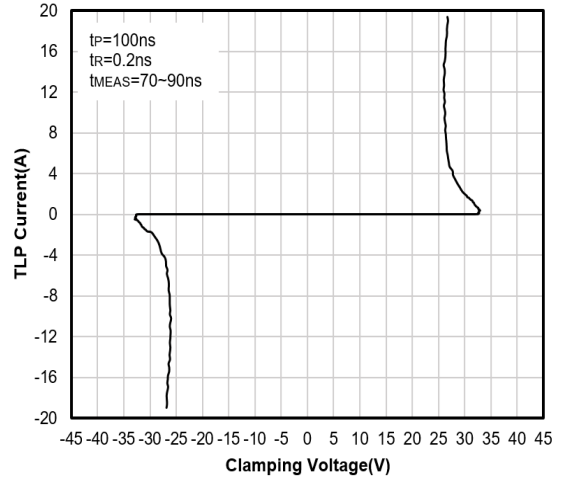

TLP Curve

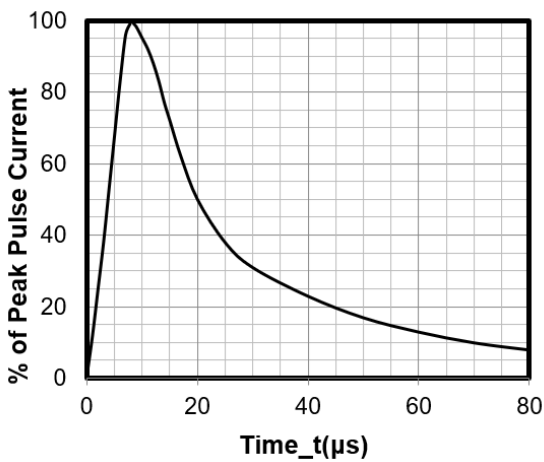

8 X 20μs Pulse Waveform

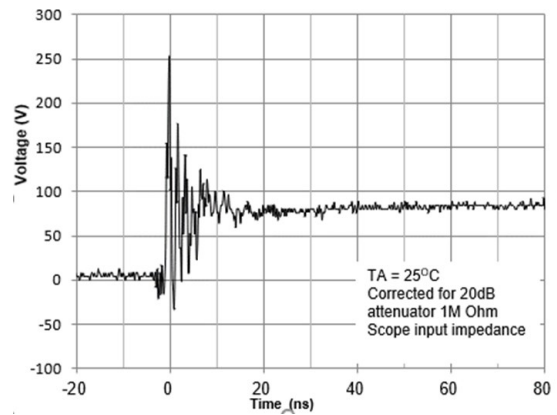

**ESD Clamping Voltage
8 kV Contact per IEC61000-4-2**

SOT-23 Package Outline Drawing

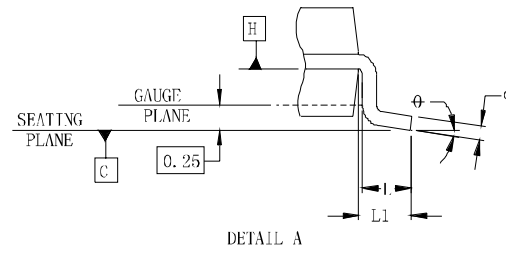
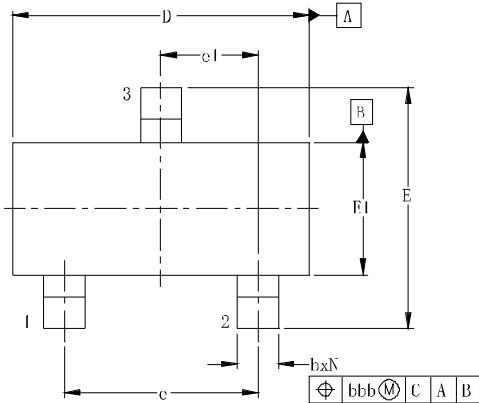

| DIMENSIONS | | | | | | |
|------------|--------|-------|-------|-------------|------|------|
| SYM | INCHES | | | MILLIMETERS | | |
| | MIN | NOM | MAX | MIN | NOM | MAX |
| A | 0.035 | - | 0.044 | 0.89 | - | 1.12 |
| A1 | 0.000 | - | 0.004 | 0.01 | - | 0.10 |
| A2 | 0.035 | 0.037 | 0.040 | 0.88 | 0.95 | 1.02 |
| b | 0.012 | - | 0.020 | 0.30 | - | 0.51 |
| c | 0.003 | - | 0.007 | 0.08 | - | 0.18 |
| D | 0.110 | 0.114 | 0.120 | 2.80 | 2.90 | 3.04 |
| E | 0.082 | 0.093 | 0.104 | 2.10 | 2.37 | 2.64 |
| E1 | 0.047 | 0.051 | 0.055 | 1.20 | 1.30 | 1.40 |
| e | 0.075 | | | 1.90BSC | | |
| e1 | 0.037 | | | 0.95BSC | | |
| L | 0.015 | 0.020 | 0.024 | 0.40 | 0.50 | 0.60 |
| L1 | 0.022 | | | 0.55 | | |
| N | 3 | | | 3 | | |
| ϕ | 0° | - | 8° | 0° | - | 8° |
| aaa | 0.004 | | | 0.10 | | |
| bbb | 0.008 | | | 0.20 | | |

Suggested Land Pattern

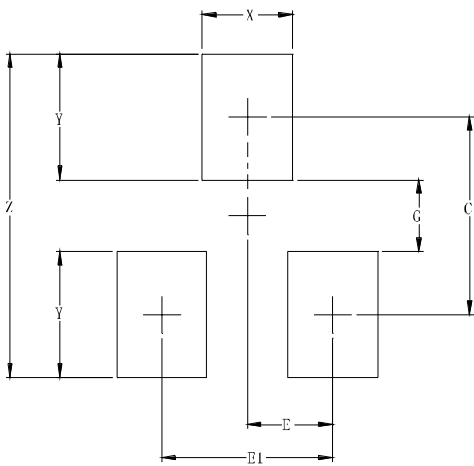

| DIMENSIONS | | |
|------------|--------|-------------|
| SYM | INCHES | MILLIMETERS |
| C | 0.087 | 2.20 |
| E | 0.037 | 0.95 |
| E1 | 0.075 | 1.90 |
| G | 0.031 | 0.80 |
| X | 0.039 | 1.00 |
| Y | 0.055 | 1.40 |
| Z | 0.141 | 3.60 |

Contact Information

Changzhou D-first Electronics CO.,Ltd.

www.first-electronic.com

Email: xhf@first-electronic.cn

Phone: +86 (0519) 8817 1671